

Section 8

Stainless Steel Fittings - 150lbs & Twin Ferrule

150lbs Stainless Steel Fittings
Twin Ferrule Stainless Steel Fittings

Page No

216 - 220

221 - 224

Section 8

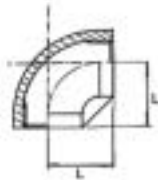

PIPE FITTINGS - 150 LBS 316 STAINLESS STEEL (ASTM A 351)

90° EQUAL ELBOW**BSPT FEMALE**

PART NUMBER	THREAD	L	PRICE
SJ-F10-02	1/8" BSPT	19 mm	£ 2.85
SJ-F10-04	1/4" BSPT	21 mm	£ 2.85
SJ-F10-06	3/8" BSPT	25 mm	£ 3.34
SJ-F10-08	1/2" BSPT	28 mm	£ 3.99
SJ-F10-12	3/4" BSPT	33 mm	£ 5.85
SJ-F10-16	1" BSPT	38 mm	£ 7.52
SJ-F10-20	1.1/4" BSPT	45 mm	£12.00
SJ-F10-24	1.1/2" BSPT	50 mm	£14.83
SJ-F10-32	2" BSPT	58 mm	£21.95

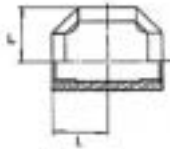
EQUAL TEE**BSPT FEMALE**

PART NUMBER	THREAD	L	PRICE
SJ-F11-02	1/8" BSPT	19 mm	£ 3.86
SJ-F11-04	1/4" BSPT	21 mm	£ 3.86
SJ-F11-06	3/8" BSPT	25 mm	£ 4.44
SJ-F11-08	1/2" BSPT	28 mm	£ 5.49
SJ-F11-12	3/4" BSPT	33 mm	£ 7.52
SJ-F11-16	1" BSPT	38 mm	£ 9.75
SJ-F11-20	1.1/4" BSPT	45 mm	£16.09
SJ-F11-24	1.1/2" BSPT	50 mm	£19.03
SJ-F11-32	2" BSPT	58 mm	£27.81

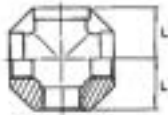
EQUAL CROSS**BSPT FEMALE**

PART NUMBER	THREAD	L	PRICE
SJ-F12-02	1/8" BSPT	19 mm	£ 6.54
SJ-F12-04	1/4" BSPT	21 mm	£ 6.54
SJ-F12-06	3/8" BSPT	25 mm	£ 7.40
SJ-F12-08	1/2" BSPT	28 mm	£ 8.54
SJ-F12-12	3/4" BSPT	33 mm	£12.11
SJ-F12-16	1" BSPT	38 mm	£15.04
SJ-F12-20	1.1/4" BSPT	45 mm	£24.23
SJ-F12-24	1.1/2" BSPT	50 mm	£28.25
SJ-F12-32	2" BSPT	58 mm	£42.67

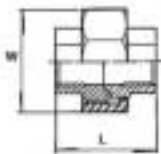
FEMALE HEXAGON UNION**BSPT FEMALE (2 piece)**

PART NUMBER	THREAD	L	W	PRICE
SJ-F13-02	1/8" BSPT	37 mm	27 mm	£ 9.75
SJ-F13-04	1/4" BSPT	40 mm	27 mm	£ 9.75
SJ-F13-06	3/8" BSPT	46 mm	32 mm	£10.57
SJ-F13-08	1/2" BSPT	54 mm	41 mm	£12.41
SJ-F13-12	3/4" BSPT	60 mm	50 mm	£14.63
SJ-F13-16	1" BSPT	66 mm	55 mm	£21.95
SJ-F13-20	1.1/4" BSPT	72 mm	70 mm	£32.11
SJ-F13-24	1.1/2" BSPT	81 mm	75 mm	£42.67
SJ-F13-32	2" BSPT	91 mm	90 mm	£54.00

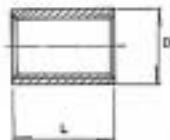
THREADED FULL SOCKET (PARALLEL)**BSP FEMALE**

PART NUMBER	THREAD	L	D	PRICE
SJ-F14-02	1/8" BSP	17 mm	14.0 mm	£ 2.44
SJ-F14-04	1/4" BSP	25 mm	18.5 mm	£ 2.44
SJ-F14-06	3/8" BSP	26 mm	21.3 mm	£ 2.68
SJ-F14-08	1/2" BSP	34 mm	26.4 mm	£ 3.66
SJ-F14-12	3/4" BSP	36 mm	31.8 mm	£ 4.47
SJ-F14-16	1" BSP	43 mm	39.5 mm	£ 7.32
SJ-F14-20	1.1/4" BSP	48 mm	48.3 mm	£11.38
SJ-F14-24	1.1/2" BSP	48 mm	54.5 mm	£12.60
SJ-F14-32	2" BSP	56 mm	66.3 mm	£18.29



PIPE FITTINGS - 150 LBS 316 STAINLESS STEEL (ASTM A 351)

THREADED HALF SOCKET (PARALLEL)

BSP FEMALE

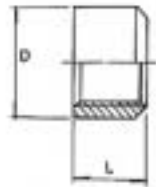

PART NUMBER	THREAD	L	D	PRICE
SJ-F15-02	1/8" BSP	9 mm	14.0 mm	£ 1.91
SJ-F15-04	1/4" BSP	11 mm	18.5 mm	£ 1.91
SJ-F15-06	3/8" BSP	12 mm	21.3 mm	£ 1.91
SJ-F15-08	1/2" BSP	15 mm	26.4 mm	£ 2.24
SJ-F15-12	3/4" BSP	17 mm	31.8 mm	£ 3.66
SJ-F15-16	1" BSP	19 mm	39.5 mm	£ 5.29
SJ-F15-20	1.1/4" BSP	22 mm	48.3 mm	£ 6.51
SJ-F15-24	1.1/2" BSP	22 mm	54.5 mm	£ 6.92
SJ-F15-32	2" BSP	26 mm	66.3 mm	£10.57

90° STREET ELBOW

BSPT MALE x BSPT FEMALE

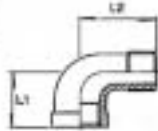

PART NUMBER	THREAD	L1	L2	PRICE
SJ-F16-02	1/8" BSPT	19 mm	25 mm	£ 3.66
SJ-F16-04	1/4" BSPT	21 mm	29 mm	£ 3.66
SJ-F16-06	3/8" BSPT	25 mm	37 mm	£ 3.86
SJ-F16-08	1/2" BSPT	28 mm	41 mm	£ 5.08
SJ-F16-12	3/4" BSPT	33 mm	48 mm	£ 6.92
SJ-F16-16	1" BSPT	38 mm	54 mm	£10.17
SJ-F16-20	1.1/4" BSPT	45 mm	61 mm	£17.07
SJ-F16-24	1.1/2" BSPT	50 mm	70 mm	£21.54
SJ-F16-32	2" BSPT	58 mm	83 mm	£31.70

45° ELBOW

BSPT FEMALE



PART NUMBER	THREAD	L	PRICE
SJ-F17-02	1/8" BSPT	18 mm	£ 3.46
SJ-F17-04	1/4" BSPT	19 mm	£ 3.46
SJ-F17-06	3/8" BSPT	20 mm	£ 4.03
SJ-F17-08	1/2" BSPT	22 mm	£ 4.80
SJ-F17-12	3/4" BSPT	25 mm	£ 6.51
SJ-F17-16	1" BSPT	29 mm	£ 8.09
SJ-F17-20	1.1/4" BSPT	33 mm	£12.41
SJ-F17-24	1.1/2" BSPT	36 mm	£16.29
SJ-F17-32	2" BSPT	43 mm	£22.35

ROUND BLANKING CAP

BSPT FEMALE



PART NUMBER	THREAD	L	D	PRICE
SJ-F18-02	1/8" BSPT	13 mm	14.5 mm	£ 2.36
SJ-F18-04	1/4" BSPT	15 mm	17.5 mm	£ 2.36
SJ-F18-06	3/8" BSPT	17 mm	21.5 mm	£ 2.77
SJ-F18-08	1/2" BSPT	19 mm	27.0 mm	£ 2.96
SJ-F18-12	3/4" BSPT	22 mm	33.5 mm	£ 4.03
SJ-F18-16	1" BSPT	24 mm	40.5 mm	£ 5.86
SJ-F18-20	1.1/4" BSPT	27 mm	50.0 mm	£10.17
SJ-F18-24	1.1/2" BSPT	27 mm	57.0 mm	£12.41
SJ-F18-32	2" BSPT	32 mm	70.0 mm	£17.39

SQUARE HEAD PLUG

BSPT MALE



PART NUMBER	THREAD	L	D	PRICE
SJ-F19-02	1/8" BSPT	20 mm	7 mm	£ 2.24
SJ-F19-04	1/4" BSPT	21 mm	8 mm	£ 2.24
SJ-F19-06	3/8" BSPT	23 mm	10 mm	£ 2.44
SJ-F19-08	1/2" BSPT	28 mm	12 mm	£ 2.64
SJ-F19-12	3/4" BSPT	33 mm	14 mm	£ 3.66
SJ-F19-16	1" BSPT	35 mm	17 mm	£ 5.08
SJ-F19-20	1.1/4" BSPT	37 mm	19 mm	£ 8.54
SJ-F19-24	1.1/2" BSPT	37 mm	22 mm	£11.30
SJ-F19-32	2" BSPT	42 mm	24 mm	£15.45



PIPE FITTINGS - 150 LBS 316 STAINLESS STEEL (ASTM A 351)

HEXAGON HEAD BLANKING PLUG

BSPT MALE

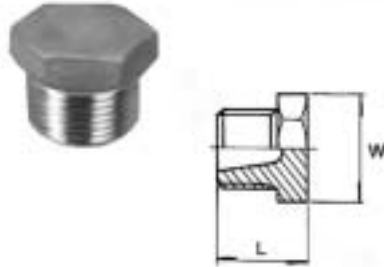

PART NUMBER	THREAD	L	W	PRICE
SJ-F20-02	1/8" BSPT	13 mm	12 mm	£ 2.44
SJ-F20-04	1/4" BSPT	15 mm	15 mm	£ 2.44
SJ-F20-06	3/8" BSPT	17 mm	19 mm	£ 2.68
SJ-F20-08	1/2" BSPT	20 mm	23 mm	£ 3.26
SJ-F20-12	3/4" BSPT	24 mm	29 mm	£ 4.27
SJ-F20-16	1" BSPT	27 mm	36 mm	£ 6.30
SJ-F20-20	1.1/4" BSPT	31 mm	45 mm	£10.57
SJ-F20-24	1.1/2" BSPT	33 mm	50 mm	£14.23
SJ-F20-32	2" BSPT	38 mm	63 mm	£19.72

HEXAGON LOCK NUT (PARALLEL)

BSP FEMALE



PART NUMBER	THREAD	L	W	PRICE
SJ-F21-02	1/8" BSP	5 mm	14 mm	£ 1.63
SJ-F21-04	1/4" BSP	6 mm	22 mm	£ 1.63
SJ-F21-06	3/8" BSP	7 mm	27 mm	£ 1.83
SJ-F21-08	1/2" BSP	8 mm	30 mm	£ 2.44
SJ-F21-12	3/4" BSP	9 mm	38 mm	£ 2.64
SJ-F21-16	1" BSP	10 mm	44 mm	£ 4.68
SJ-F21-20	1.1/4" BSP	11 mm	54 mm	£ 6.92
SJ-F21-24	1.1/2" BSP	12 mm	64 mm	£ 7.37
SJ-F21-32	2" BSP	13 mm	73 mm	£10.57

BARREL NIPPLE

BSPT MALE

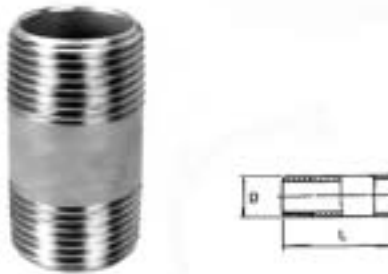

PART NUMBER	THREAD	L	D	PRICE
SJ-F22-02	1/8" BSPT	40 mm	10.2 mm	£ 2.64
SJ-F22-04	1/4" BSPT	40 mm	13.5 mm	£ 2.65
SJ-F22-06	3/8" BSPT	40 mm	17.2 mm	£ 2.85
SJ-F22-08	1/2" BSPT	60 mm	21.3 mm	£ 3.86
SJ-F22-12	3/4" BSPT	60 mm	26.9 mm	£ 5.29
SJ-F22-16	1" BSPT	60 mm	33.7 mm	£ 6.09
SJ-F22-20	1.1/4" BSPT	80 mm	42.4 mm	£11.38
SJ-F22-24	1.1/2" BSPT	80 mm	48.3 mm	£13.01
SJ-F22-32	2" BSPT	100 mm	60.3 mm	£18.29

HEXAGON BLANKING CAP (PARALLEL)

BSP FEMALE

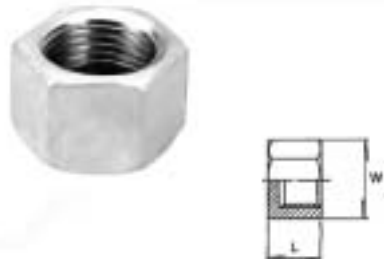

PART NUMBER	THREAD	L	W	PRICE
SJ-F23-02	1/8" BSP	13 mm	13 mm	£ 1.76
SJ-F23-04	1/4" BSP	15 mm	17 mm	£ 1.76
SJ-F23-06	3/8" BSP	17 mm	21 mm	£ 2.03
SJ-F23-08	1/2" BSP	19 mm	26 mm	£ 2.85
SJ-F23-12	3/4" BSP	22 mm	32 mm	£ 3.74
SJ-F23-16	1" BSP	24 mm	40 mm	£ 5.69
SJ-F23-20	1.1/4" BSP	27 mm	48 mm	£ 9.30
SJ-F23-24	1.1/2" BSP	27 mm	55 mm	£11.38
SJ-F23-32	2" BSP	32 mm	69 mm	£17.48

EQUAL HEXAGON NIPPLE

BSPT MALE

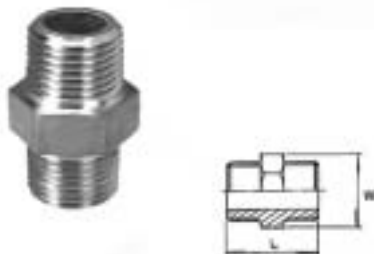

PART NUMBER	THREAD	L	W	PRICE
SJ-F24-02	1/8" BSPT	22 mm	12 mm	£ 2.64
SJ-F24-04	1/4" BSPT	24 mm	14 mm	£ 2.64
SJ-F24-06	3/8" BSPT	28 mm	19 mm	£ 2.85
SJ-F24-08	1/2" BSPT	34 mm	22 mm	£ 3.86
SJ-F24-12	3/4" BSPT	40 mm	30 mm	£ 5.29
SJ-F24-16	1" BSPT	46 mm	36 mm	£ 6.09
SJ-F24-20	1.1/4" BSPT	52 mm	46 mm	£11.38
SJ-F24-24	1.1/2" BSPT	54 mm	50 mm	£13.01
SJ-F24-32	2" BSPT	62 mm	65 mm	£18.29



PIPE FITTINGS - 150 LBS 316 STAINLESS STEEL (ASTM A 351)

MALE / FEMALE HEXAGON UNION BSPT MALE x BSPT FEMALE (2 piece)



PART NUMBER	THREAD	L	W	PRICE
SJ-F26-02	1/8" BSPT	40 mm	25 mm	£12.20
SJ-F26-04	1/4" BSPT	45 mm	31 mm	£12.20
SJ-F26-06	3/8" BSPT	62 mm	37 mm	£13.21
SJ-F26-08	1/2" BSPT	57 mm	42 mm	£15.51
SJ-F26-12	3/4" BSPT	61 mm	50 mm	£27.44
SJ-F26-16	1" BSPT	70 mm	59 mm	£27.44
SJ-F26-20	1.1/4" BSPT	75 mm	69 mm	£40.16
SJ-F26-24	1.1/2" BSPT	80 mm	78 mm	£53.34
SJ-F26-32	2" BSPT	89 mm	93 mm	£67.57

HOSE TAIL ADAPTOR BSPT MALE x HOSE BARB

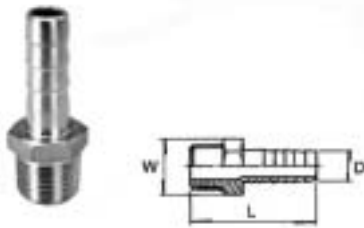

PART NUMBER	THREAD	D (hose)	L	W	PRICE
SJ-F29-04	1/4" BSPT	6.4 mm	51 mm	14 mm	£ 5.29
SJ-F29-06	3/8" BSPT	9.5 mm	55 mm	17 mm	£ 6.51
SJ-F29-08	1/2" BSPT	12.7 mm	65 mm	23 mm	£ 8.54
SJ-F29-12	3/4" BSPT	19.0 mm	74 mm	29 mm	£10.77
SJ-F29-16	1" BSPT	25.4 mm	83 mm	38 mm	£13.42
SJ-F29-20	1.1/4" BSPT	31.0 mm	100 mm	46 mm	£19.10
SJ-F29-24	1.1/2" BSPT	38.0 mm	103 mm	54 mm	£23.97
SJ-F29-32	2" BSPT	50.0 mm	115 mm	63 mm	£33.33

HEXAGON REDUCING BUSHES BSPT MALE x BSPT FEMALE

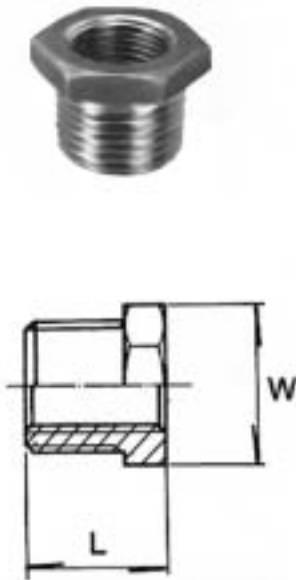

PART NUMBER	THREAD MALE X FEMALE	L	W	PRICE
SJ-F31-0402	1/4" x 1/8"	15 mm	14 mm	£ 2.44
SJ-F31-0602	3/8" x 1/8"	17 mm	19 mm	£ 2.44
SJ-F31-0604	3/8" x 1/4"	17 mm	19 mm	£ 2.44
SJ-F31-0802	1/2" x 1/8"	20 mm	22 mm	£ 3.26
SJ-F31-0804	1/2" x 1/4"	20 mm	22 mm	£ 3.26
SJ-F31-0806	1/2" x 3/8"	20 mm	22 mm	£ 3.26
SJ-F31-1202	3/4" x 1/8"	24 mm	30 mm	£ 4.27
SJ-F31-1204	3/4" x 1/4"	24 mm	30 mm	£ 4.27
SJ-F31-1206	3/4" x 3/8"	24 mm	30 mm	£ 4.27
SJ-F31-1208	3/4" x 1/2"	24 mm	30 mm	£ 4.27
SJ-F31-1604	1" x 1/4"	27 mm	36 mm	£ 6.30
SJ-F31-1606	1" x 3/8"	27 mm	36 mm	£ 6.30
SJ-F31-1608	1" x 1/2"	27 mm	36 mm	£ 6.30
SJ-F31-1612	1" x 3/4"	27 mm	36 mm	£ 6.30
SJ-F31-2008	1.1/4" x 1/2"	31 mm	46 mm	£10.57
SJ-F31-2012	1.1/4" x 3/4"	31 mm	46 mm	£10.57
SJ-F31-2016	1.1/4" x 1"	31 mm	46 mm	£10.57
SJ-F31-2408	1.1/2" x 1/2"	33 mm	50 mm	£12.60
SJ-F31-2412	1.1/2" x 3/4"	33 mm	50 mm	£12.60
SJ-F31-2416	1.1/2" x 1"	33 mm	50 mm	£12.60
SJ-F31-2420	1.1/2" x 1.1/4"	33 mm	50 mm	£12.60
SJ-F31-3212	2" x 3/4"	38 mm	65 mm	£18.09
SJ-F31-3216	2" x 1"	38 mm	65 mm	£18.09
SJ-F31-3220	2" x 1.1/4"	38 mm	65 mm	£18.09
SJ-F31-3224	2" x 1.1/2"	38 mm	65 mm	£18.09

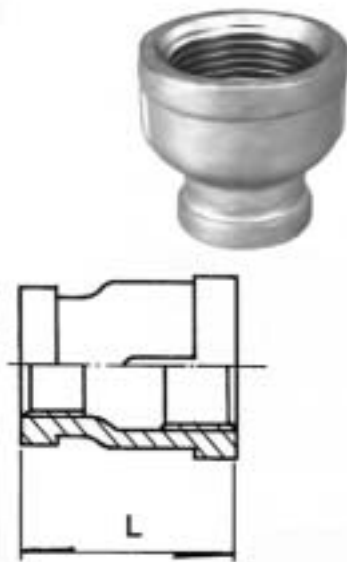

PIPE FITTINGS - 150 LBS 316 STAINLESS STEEL (ASTM A 351)

FEMALE REDUCING SOCKET**BSPT FEMALE**

PART NUMBER	THREAD FEMALE X FEMALE	L	PRICE
SJ-F32-0402	1/4" x 1/8"	27 mm	£ 4.06
SJ-F32-0602	3/8" x 1/8"	30 mm	£ 4.89
SJ-F32-0604	3/8" x 1/4"	30 mm	£ 4.89
SJ-F32-0802	1/2" x 1/8"	36 mm	£ 6.51
SJ-F32-0804	1/2" x 1/4"	36 mm	£ 6.51
SJ-F32-0806	1/2" x 3/8"	36 mm	£ 6.51
SJ-F32-1202	3/4" x 1/8"	39 mm	£ 8.54
SJ-F32-1204	3/4" x 1/4"	39 mm	£ 8.54
SJ-F32-1206	3/4" x 3/8"	39 mm	£ 8.54
SJ-F32-1208	3/4" x 1/2"	39 mm	£ 8.54
SJ-F32-1604	1" x 1/4"	45 mm	£10.17
SJ-F32-1606	1" x 3/8"	45 mm	£10.17
SJ-F32-1608	1" x 1/2"	45 mm	£10.17
SJ-F32-1612	1" x 3/4"	45 mm	£10.17
SJ-F32-2008	1.1/4" x 1/2"	50 mm	£14.23
SJ-F32-2012	1.1/4" x 3/4"	50 mm	£14.23
SJ-F32-2016	1.1/4" x 1"	50 mm	£14.23
SJ-F32-2408	1.1/2" x 1/2"	55 mm	£18.29
SJ-F32-2412	1.1/2" x 3/4"	55 mm	£18.29
SJ-F32-2416	1.1/2" x 1"	55 mm	£18.29
SJ-F32-2420	1.1/2" x 1.1/4"	55 mm	£18.29
SJ-F32-3212	2" x 3/4"	65 mm	£28.86
SJ-F32-3216	2" x 1"	65 mm	£28.86
SJ-F32-3220	2" x 1.1/4"	65 mm	£28.86
SJ-F32-3224	2" x 1.1/2"	65 mm	£28.86

REDUCING HEXAGON NIPPLE**BSPT MALE**

PART NUMBER	THREAD MALE X MALE	L	PRICE
SJ-F33-0402	1/4" x 1/8"	24 mm	£ 4.06
SJ-F33-0602	3/8" x 1/8"	28 mm	£ 4.06
SJ-F33-0604	3/8" x 1/4"	28 mm	£ 4.06
SJ-F33-0802	1/2" x 1/8"	34 mm	£ 4.47
SJ-F33-0804	1/2" x 1/4"	34 mm	£ 4.47
SJ-F33-0806	1/2" x 3/8"	34 mm	£ 4.47
SJ-F33-1204	3/4" x 1/4"	40 mm	£ 5.94
SJ-F33-1206	3/4" x 3/8"	40 mm	£ 5.94
SJ-F33-1208	3/4" x 1/2"	40 mm	£ 5.94
SJ-F33-1604	1" x 1/4"	46 mm	£ 8.12
SJ-F33-1606	1" x 3/8"	46 mm	£ 8.12
SJ-F33-1608	1" x 1/2"	46 mm	£ 8.12
SJ-F33-1612	1" x 3/4"	46 mm	£ 8.12
SJ-F33-2008	1.1/4" x 1/2"	52 mm	£14.23
SJ-F33-2012	1.1/4" x 3/4"	52 mm	£14.23
SJ-F33-2016	1.1/4" x 1"	52 mm	£14.23
SJ-F33-2408	1.1/2" x 1/2"	54 mm	£15.85
SJ-F33-2412	1.1/2" x 3/4"	54 mm	£15.85
SJ-F33-2416	1.1/2" x 1"	54 mm	£15.85
SJ-F33-2420	1.1/2" x 1.1/4"	54 mm	£15.85
SJ-F33-3212	2" x 3/4"	60 mm	£21.14
SJ-F33-3216	2" x 1"	60 mm	£21.14
SJ-F33-3220	2" x 1.1/4"	60 mm	£21.14
SJ-F33-3224	2" x 1.1/2"	60 mm	£21.14



The LET-LOK® range of connectors has been developed to fill the rapidly increasing demand for tube fittings suitable for high pressure use in environments such as petrochemical, fluidpower, nuclear, electronic, as well as other major industries.

LET-LOK® tube fittings have been carefully manufactured and tested to withstand the demands of high performance tube fittings, such as high pressure, impulse, vibration, vacuum and temperature. These tube fittings are manufactured to exacting tolerances using the most modern and advanced computerised automation.

LET-LOK® tube fittings are composed of four parts: 1) body, 2) front ferrule, 3) back ferrule, and 4) nut.

LET-LOK® fittings come assembled. For use insert the tube into the fitting through the back of the nut until the tubing bottoms out on the tube stop of the fitting body, then rotate the nut one and one quarter turns from finger tight. During this rotation of the nut, the front ferrule will move along the tubing. The increased pressure of this movement of the front ferrule causes the nose of the back ferrule to grip the tubing. As the back ferrule grips the tubing it fits the tubing it lifts the front ferrule out to form a line to line fit, or full faced seal, of the front ferrule and the fitting body. This full faced seal is accompanied by a seal at the tubing and the I.D. of the nose of the front ferrule. At the completion of one and one quarter turns of the nut, the front ferrule is sealing the media in and the back ferrule is holding the tube in place.

Material: All components are made from the same material.

Suitable Tubing Materials: Stainless Steel - seamless, fully annealed and welded redrawn, suitable for bending.

Maximum Hardness - Rockwell B90.

ASTM A 269

ASTM A 213

Types: 304 and 316.

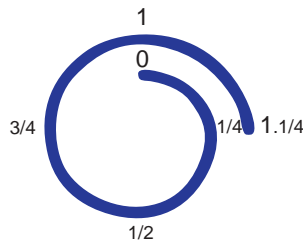
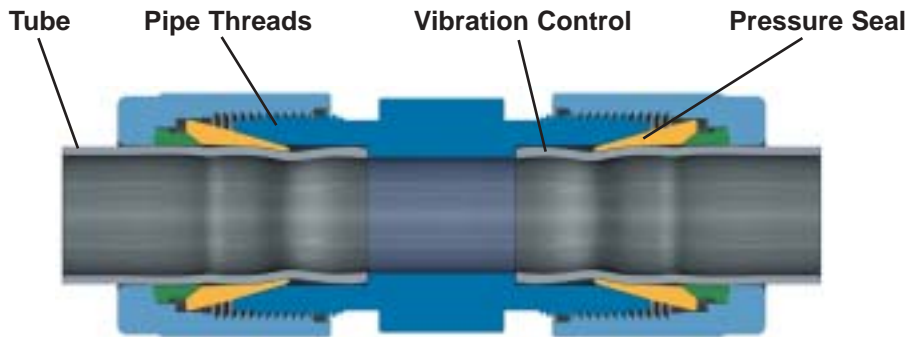

Tightening of only 3/4 turn is sufficient for sizes from 1/16th to 3/16th of an inch and those between 2-4 mm.

LET-LOK® IS ALSO AVAILABLE IN IMPERIAL SIZES AND IN A RANGE OF MATERIALS INCLUDING BRASS, MONEL & HASTELLOY C - FOR FURTHER INFORMATION PLEASE CONTACT YOUR DISTRIBUTOR

ASSEMBLY INSTRUCTIONS

- 1) Insert the tubing nesting it in the bottom of the body counterbore.
- 2) Make a mark at the "0" position and be sure the nut is finger tight. Now, simply tighten the nut 1-1/4 turns.

REASSEMBLY INSTRUCTIONS

LET-LOK® fittings may be assembled and disassembled repeatedly. The following instructions should be carried out to reassemble a fitting.

- 1) Insert the tubing end with the previously set ferrules into the fitting body and tighten the nut to a handtight condition.
- 2) With a wrench, tighten the nut until a sharp rise in torque is felt, then simply snug with wrench.

TUBING DATA CHART - STAINLESS STEEL

WALL THICKNESS OF TUBE IN INCH

304 or 316 stainless steel tubing meeting ASTM A-213, 269 or 249 specifications or equivalent. Maximum allowable working pressure in PSI for temperatures between -325°F and 100°F. Allowable stress -18,750 PSI. Calculated burst pressures are four times maximum allowable working pressures.

Tubing O.D.		WALL THICKNESS OF TUBE IN INCH							
MM	Inch	.020	.028	.035	.049	.065	.083	.095	.109
6	1/4	4369	4613	5906	8644	11738			
8	5/16		3619	4613	6731	9225			
10	3/8			3788	5475	7538			
12	1/2			2775	3975	5438	7181		
16	5/8			2194	3131	4256	5569	6488	



LET-LOK®

BACK FERRULE



PART NUMBER	TUBE O.D.	PRICE
HA-760LB06M	6 mm	£ 1.01
HA-760LB08M	8 mm	£ 1.20
HA-760LB10M	10 mm	£ 1.29
HA-760LB12M	12 mm	£ 1.75
HA-760LB14M	14 mm	£ 2.02
HA-760LB15M	15 mm	£ 2.02
HA-760LB16M	16 mm	£ 2.02

FRONT FERRULE



PART NUMBER	TUBE O.D.	PRICE
HA-760LF06M	6 mm	£ 1.11
HA-760LF08M	8 mm	£ 1.29
HA-760LF10M	10 mm	£ 1.29
HA-760LF12M	12 mm	£ 1.84
HA-760LF14M	14 mm	£ 2.12
HA-760LF15M	15 mm	£ 2.12
HA-760LF16M	16 mm	£ 2.12

TUBE INSERT



PART NUMBER	TUBE O.D.	TUBE I.D.	MIN. OPENING	PRICE
HA-760L064M	6 mm	4 mm	2.8 mm	£ 1.70
HA-760L086M	8 mm	6 mm	4.4 mm	£ 2.12
HA-760L108M	10 mm	8 mm	6.4 mm	£ 2.00
HA-760L128M	12 mm	8 mm	6.4 mm	£ 3.01
HA-760L121M	12 mm	10 mm	8.3 mm	£ 2.78

NUT



PART NUMBER	TUBE O.D.	WIDTH ACROSS HEX.	LENGTH	PRICE
HA-761L-06M	6 mm	14 mm	12.7 mm	£ 1.65
HA-761L-08M	8 mm	16 mm	13.5 mm	£ 1.75
HA-761L-10M	10 mm	19 mm	15.1 mm	£ 2.12
HA-761L-12M	12 mm	22 mm	17.4 mm	£ 3.59
HA-761L-15M	15 mm	25 mm	17.4 mm	£ 5.08
HA-761L-16M	16 mm	25 mm	17.4 mm	£ 5.08

UNION - TUBE TO TUBE



PART NUMBER	TUBE O.D.	MIN. OPENING	LENGTH	PRICE
HA-762L-06M	6 mm	4.8 mm	41.0 mm	£ 7.71
HA-762L-08M	8 mm	6.4 mm	43.2 mm	£ 8.29
HA-762L-10M	10 mm	7.9 mm	45.9 mm	£11.00
HA-762L-12M	12 mm	9.5 mm	51.2 mm	£16.60
HA-762L-14M	14 mm	11.1 mm	52.0 mm	£20.92
HA-762L-15M	15 mm	11.9 mm	52.0 mm	£20.92
HA-762L-16M	16 mm	12.7 mm	52.0 mm	£20.92

REDUCING UNION - TUBE TO TUBE



PART NUMBER	TUBE O.D.	TUBE O.D.	MIN. OPENING	LENGTH	PRICE
HA-763L06M2	6 mm	2 mm	1.7 mm	38.6 mm	£ 8.64
HA-763L06M3	6 mm	3 mm	2.4 mm	38.6 mm	£ 7.95
HA-763L06M4	6 mm	4 mm	2.4 mm	39.4 mm	£ 7.95
HA-763L08M6	8 mm	6 mm	4.8 mm	42.3 mm	£ 8.05
HA-763L10M6	10 mm	6 mm	4.8 mm	44.5 mm	£10.92
HA-763L10M8	10 mm	8 mm	6.4 mm	45.1 mm	£10.92
HA-763L12M6	12 mm	6 mm	4.8 mm	47.0 mm	£17.06
HA-763L12M8	12 mm	8 mm	6.4 mm	47.8 mm	£17.06
HA-763L1210	12 mm	10 mm	7.9 mm	48.7 mm	£17.06
HA-763L1610	16 mm	10 mm	7.9 mm	49.5 mm	£21.68
HA-763L1612	16 mm	12 mm	9.5 mm	52.0 mm	£21.33

LET-LOK® IS ALSO AVAILABLE IN IMPERIAL
PLEASE CONTACT YOUR PARKAIR DISTRIBUTOR



LET-LOK®

UNION TEE - ALL TUBE



PART NUMBER	TUBE O.D.	MIN. OPENING	PRICE
HA-764L-06M	6 mm	4.8 mm	£15.02
HA-764L-08M	8 mm	6.4 mm	£17.32
HA-764L-10M	10 mm	7.9 mm	£19.62
HA-764L-12M	12 mm	9.5 mm	£29.95
HA-764L-14M	14 mm	11.1 mm	£32.25
HA-764L-15M	15 mm	11.9 mm	£32.25
HA-764L-16M	16 mm	12.7 mm	£32.25

UNION ELBOW - TUBE TO TUBE



PART NUMBER	TUBE O.D.	MIN. OPENING	PRICE
HA-765L-06M	6 mm	4.8 mm	£10.92
HA-765L-08M	8 mm	6.4 mm	£11.43
HA-765L-10M	10 mm	7.9 mm	£13.08
HA-765L-12M	12 mm	9.5 mm	£21.94
HA-765L-14M	14 mm	11.1 mm	£22.76
HA-765L-15M	15 mm	11.9 mm	£22.76
HA-765L-16M	16 mm	12.7 mm	£22.76

FEMALE CONNECTOR - TUBE TO FEMALE BSPP



PART NUMBER	TUBE O.D.	BSPP	MIN. OPENING	LENGTH	PRICE
HA-766G06M4	6 mm	1/4"	4.8 mm	37.6 mm	£11.06
HA-766G06M6	6 mm	3/8"	4.8 mm	37.6 mm	£15.66
HA-766G06M8	6 mm	1/2"	4.8 mm	43.5 mm	£15.20
HA-766G08M4	8 mm	1/4"	5.5 mm	38.5 mm	£11.43
HA-766G08M6	8 mm	3/8"	6.5 mm	36.2 mm	£16.21
HA-766G08M8	8 mm	1/2"	7.0 mm	41.0 mm	£19.72
HA-766G10M4	10 mm	1/4"	5.5 mm	39.4 mm	£12.57
HA-766G10M6	10 mm	3/8"	6.5 mm	38.8 mm	£14.67
HA-766G10M8	10 mm	1/2"	7.0 mm	42.1 mm	£19.76
HA-766G12M4	12 mm	1/4"	5.5 mm	41.9 mm	£15.05
HA-766G12M6	12 mm	3/8"	6.5 mm	44.4 mm	£15.39
HA-766G12M8	12 mm	1/2"	7.0 mm	48.2 mm	£22.06

MALE CONNECTOR - BSPT



PART NUMBER	TUBE O.D.	BSPT	MIN. OPENING	LENGTH	PRICE
HA-768R06M2	6 mm	1/8"	4.8 mm	32.8 mm	£ 4.79
HA-768R06M4	6 mm	1/4"	4.8 mm	37.9 mm	£ 5.15
HA-768R06M6	6 mm	3/8"	4.8 mm	38.4 mm	£ 6.44
HA-768R06M8	6 mm	1/2"	4.8 mm	44.7 mm	£ 8.76
HA-768R08M2	8 mm	1/8"	4.8 mm	34.2 mm	£ 5.25
HA-768R08M6	8 mm	3/8"	6.4 mm	39.2 mm	£ 6.83
HA-768R08M8	8 mm	1/2"	6.4 mm	45.5 mm	£ 9.12
HA-768R10M2	10 mm	1/8"	4.8 mm	36.3 mm	£ 6.17
HA-768R10M4	10 mm	1/4"	7.9 mm	40.9 mm	£ 6.83
HA-768R10M6	10 mm	3/8"	7.9 mm	40.9 mm	£ 7.83
HA-768R10M8	10 mm	1/2"	7.9 mm	46.5 mm	£ 9.40
HA-768R12M4	12 mm	1/4"	7.1 mm	43.4 mm	£10.13
HA-768R12M6	12 mm	3/8"	9.5 mm	43.4 mm	£10.41
HA-768R12M8	12 mm	1/2"	9.5 mm	49.0 mm	£11.52
HA-768R15M8	15 mm	1/2"	11.9 mm	49.0 mm	£11.98
HA-768R16M4	16 mm	1/4"	7.1 mm	44.1 mm	£12.17
HA-768R16M6	16 mm	3/8"	9.5 mm	44.1 mm	£11.69

LET-LOK® IS ALSO AVAILABLE IN IMPERIAL
PLEASE CONTACT YOUR PARKAIR DISTRIBUTOR



LET-LOK®

MALE CONNECTOR - BSPP



PART NUMBER	TUBE O.D.	BSPP	MIN. OPENING	LENGTH	PRICE
HA-768G06M2	6 mm	1/8"	4.0 mm	32.3 mm	£ 7.79
HA-768G06M4	6 mm	1/4"	4.8 mm	37.6 mm	£ 8.41
HA-768G06M6	6 mm	3/8"	4.8 mm	38.9 mm	£10.53
HA-768G06M8	6 mm	1/2"	4.8 mm	44.7 mm	£14.36
HA-768G08M2	8 mm	1/8"	4.0 mm	33.2 mm	£ 8.50
HA-768G08M4	8 mm	1/4"	6.4 mm	38.5 mm	£10.11
HA-768G08M6	8 mm	3/8"	6.4 mm	39.8 mm	£11.24
HA-768G08M8	8 mm	1/2"	6.4 mm	45.6 mm	£14.86
HA-768G10M4	10 mm	1/4"	5.9 mm	39.4 mm	£11.24
HA-768G10M6	10 mm	3/8"	7.9 mm	40.6 mm	£12.57
HA-768G10M8	10 mm	1/2"	7.9 mm	46.5 mm	£15.39
HA-768G12M4	12 mm	1/4"	5.9 mm	42.6 mm	£16.47
HA-768G12M6	12 mm	3/8"	7.9 mm	43.1 mm	£17.00
HA-768G12M8	12 mm	1/2"	9.5 mm	49.0 mm	£18.84
HA-768G1212	12 mm	3/4"	9.5 mm	52.8 mm	£24.46

MALE ELBOW - BSPT



PART NUMBER	TUBE O.D.	BSPT	MIN. OPENING	PRICE
HA-769R06M2	6 mm	1/8"	4.8 mm	£ 8.29
HA-769R06M6	6 mm	3/8"	4.8 mm	£14.94
HA-769R06M8	6 mm	1/2"	4.8 mm	£14.36
HA-769R08M2	8 mm	1/8"	4.8 mm	£ 9.40
HA-769R08M4	8 mm	1/4"	6.4 mm	£ 9.68
HA-769R08M6	8 mm	3/8"	6.4 mm	£14.00
HA-769R08M8	8 mm	1/2"	6.4 mm	£16.58
HA-769R10M4	10 mm	1/4"	7.1 mm	£11.74
HA-769R10M6	10 mm	3/8"	7.9 mm	£14.56
HA-769R10M8	10 mm	1/2"	7.9 mm	£18.70
HA-769R12M4	12 mm	1/4"	7.1 mm	£16.58
HA-769R12M6	12 mm	3/8"	9.5 mm	£16.58
HA-769R12M8	12 mm	1/2"	9.5 mm	£21.28
HA-769R1212	12 mm	3/4"	9.5 mm	£28.10
HA-769R16M6	16 mm	3/8"	9.5 mm	£21.73

BULKHEAD UNION - TUBE TO TUBE



PART NUMBER	TUBE O.D.	MIN. OPENING	LENGTH	PRICE
HA-774L-08M	8 mm	6.4 mm	61.0 mm	£14.36
HA-774L-10M	10 mm	7.9 mm	63.7 mm	£16.86
HA-774L-12M	12 mm	9.5 mm	71.0 mm	£24.41
HA-774L-15M	15 mm	11.9 mm	72.5 mm	£39.71
HA-774L-16M	16 mm	12.7 mm	72.5 mm	£39.71

UNION CROSS - ALL TUBES



PART NUMBER	TUBE O.D.	MIN. OPENING	LENGTH	PRICE
HA-7102L06M	6 mm	4.8 mm	54.0 mm	£29.03
HA-7102L08M	8 mm	6.4 mm	59.8 mm	£36.85
HA-7102L10M	10 mm	7.9 mm	67.0 mm	£36.00
HA-7102L12M	12 mm	9.5 mm	72.0 mm	£40.57
HA-7102L16M	16 mm	12.7 mm	74.0 mm	£48.63

LET-LOK® IS ALSO AVAILABLE IN IMPERIAL
PLEASE CONTACT YOUR PARKAIR DISTRIBUTOR